

AMSTRAD



**DMP2000 / DMP3000
DMP4000
PRINTER
SERVICE MANUAL**

**DMP2000/3000 SECTION ONLY.
FOR DMP4000 SEE PAGES 13 ONWARDS**

CONTENTS

	Page
Safety Note	2
Technical Specifications	2
Interface	3
Dipswitch Settings	3
Control PCB's	4
Cabinet Drawing	5
Printer Mechanism	6
Printer Mechanism Parts List	7
Block Diagram	7
Wiring Diagram	8 & 9
Circuit Diagram	10 & 11
Electrical Parts List	12
DMP4000	13 - 20

TECHNICAL SPECIFICATION

	DMP2000	DMP3000
Print System:	Impact Dot-Matrix	Impact Dot-Matrix
Print Speed	105 CPS max	105 CPS (normal character) 52 CPS (double width character)
Printing Characteristics (vertical x horizontal)	9 x 9 (normal character) 9 x 10 (expanded character) 9 x chosen amount (9 pin bit-image) 96 characters ASCII + international character sets	9 x 9 (normal character) 9 x 10 (double width character) 8 x chosen amount (bit-image) 9 x chosen amount (9 pin bit-image) 96 characters ASCII + Italics + international character sets 2.1 (width) x 2.55 (height) mm
Normal Character Size		
Print Sizes		
Standard (Pica)	10 CPI/80CPL	10 CPI/80 CPL
Mini (Elite)	12 CPI/96 CPL	12 CPI/96 CPL
Condensed	17 CPI/137 CPL	
Double Width Standard	5 CPI/40 CPL	5 CPI/40 CPL
Double Width Mini	6 CPI/48 CPL	6 CPI/48 CPL
Double Width Condensed	8.5 CPI/68 CPL	8.5 CPI/68 CPL
Number of Columns	80 (Standard) 40 (Double Width) 132 (Condensed) 66 (Double Width Condensed)	80 (Standard) 40 (Double Width) 132 (Condensed) 66 (Double Width Condensed)
Line Feed Rates	1/6 inch 1/8 inch 7/72 inch n/216 inch programmable n/72 inch programmable	1/6 inch 1/8 inch 7/72 inch n/216 inch programmable n/72 inch programmable
Line Feed Speed	200 mS(1/6 inch)	200 mS(1/6 inch)
Paper Type	4.5 to 10 inches fan-fold (tractor feed) 4 to 9.5 inches cut sheet or roll paper (friction feed)	4.5 to 10 inches fan-fold (tractor feed) 4 to 9.5 inches cut sheet or roll paper (friction feed)
Number of Copies	2 sheets (including original) 40 gsm pressure-sensitive paper train	2 sheets (including original) 40 gsm pressure-sensitive paper train
Interface	Parallel (Centronics compatible)	Parallel (Centronics compatible)
Ink Ribbon	Cassette (1 million characters life per ribbon)	Cassette (1 million characters life per ribbon)
Dimensions	380 (w) x 100 (h) x 260 (d) mm	400 (w) x 250 (d) x 100 (h) mm
Weight		4.2Kg
Mains Supply	220-240V AC 50Hz	220-240V AC 50Hz

SAFETY TEST

PLEASE NOTE: When any work is completed on this unit, correct safety tests must be carried out to ensure continued electrical safety.

PLEASE NOTE: All parts shown with the part number prefix  are Safety Items and must be replaced with similar items having an identical safety specification.

All of these items may be purchased direct from AMSTRAD PLC.

Interface

PIN	DESIGNATION	I/O	DESCRIPTION	PIN	DESTINATION	I/O	DESCRIPTION	
1	DATA STROBE	IN	Taking pin low enables receiving of DATA 0 to DATA 7. Minimum necessary pulse width is 0.5 μ S.	14	NC			
2	DATA 0 (LSB)	IN	8-bit data signal. Taking pin high or low corresponds to 1 and 0 respectively.	15	NC			
3	DATA 1				16	0V		
4	DATA 2				17	CHASSIS GND		
5	DATA 3				18	+5V	OUT	+5V (50mA max) power supply output
6	DATA 4				19	GND		Signal ground.
7	DATA 5				20	GND		Signal ground.
8	DATA 6				21	GND		Signal ground.
9	DATA 7 (MSB)				22	GND		Signal ground.
10	ACKNOWLEDGE	OUT	Active low output pulse generated when data entry and processing are completed. After this signal, subsequent data will be accepted. This signal is also generated when changing from off line to on line.	23	GND		Signal ground.	
11	BUSY	OUT	Output high under any of the following conditions: a. Going off line. b. Paper feed or printing operation. c. When a control code is received.	24	GND		Signal ground.	
12	PE	OUT	Output high when paper is out. (When on line, paper out is sensed after executing a paper feed command. When off line, paper out is always sensed.)	25	GND		Signal ground.	
13	SELECT	OUT	On line and off line correspond to high and low respectively. When off line, DATA 0 to DATA 7 are not receivable.	26	GND		Signal ground.	
				27	GND		Signal ground.	
				28	GND		Signal ground.	
				29	GND		Signal ground.	
				30	GND		Signal ground.	
				31	INPUT PRIME	IN	Taking pin low initialises printer Minimum necessary pulse width is 100 μ S	
				32	FAULT	OUT	Output low when off line	
				33	GND			
				34	NC			
				35	+5V	OUT		

DIP switch settings

Described below is how to adjust DIP switches DS1-1, DS1-2 and DS1-3 to select one of the international character sets. The following table indicates the functions of the remaining DIP switches:

SWITCH	FUNCTION	OFF	ON
DS1-1	International characters	See Chapter 2	See Chapter 2
DS1-2	International characters	See Chapter 2	See Chapter 2
DS1-3	International characters	See Chapter 2	See Chapter 2
DS1-4	CR function	CR only	CR & LF
DS1-5	Paper out sensor	Enable	Disable
DS1-6	Page length	11 inch	12 inch
DS1-7	Code unit	8 units	7 units*
DS1-8	Default character set	Standard	NLQ-Standard
DS2-1	Zero character	Unslashed	Slashed
DS2-2	Default skip perforation	Disable	Enable
DS2-3	Buffer mode	Character	Graphics
DS2-4	Buffer mode	Character/graphics	Download
DS2-5	SLCT IN signal	Not sent	Automatically sent
DS2-6	Alarm bleeper	Disable	Enable
DS2-7	Default typeface	Bold off	Condensed & Bold on
DS2-8	Default typeface	Condensed off	Bold on
DS2-9	Do not use		
DS2-10	Do not use		

* Set DS1-7 ON when using the printer with an Apple computer.

REMEMBER – Always switch the printer off before adjusting the DIP switches.

CONTROL P.C.B.'S

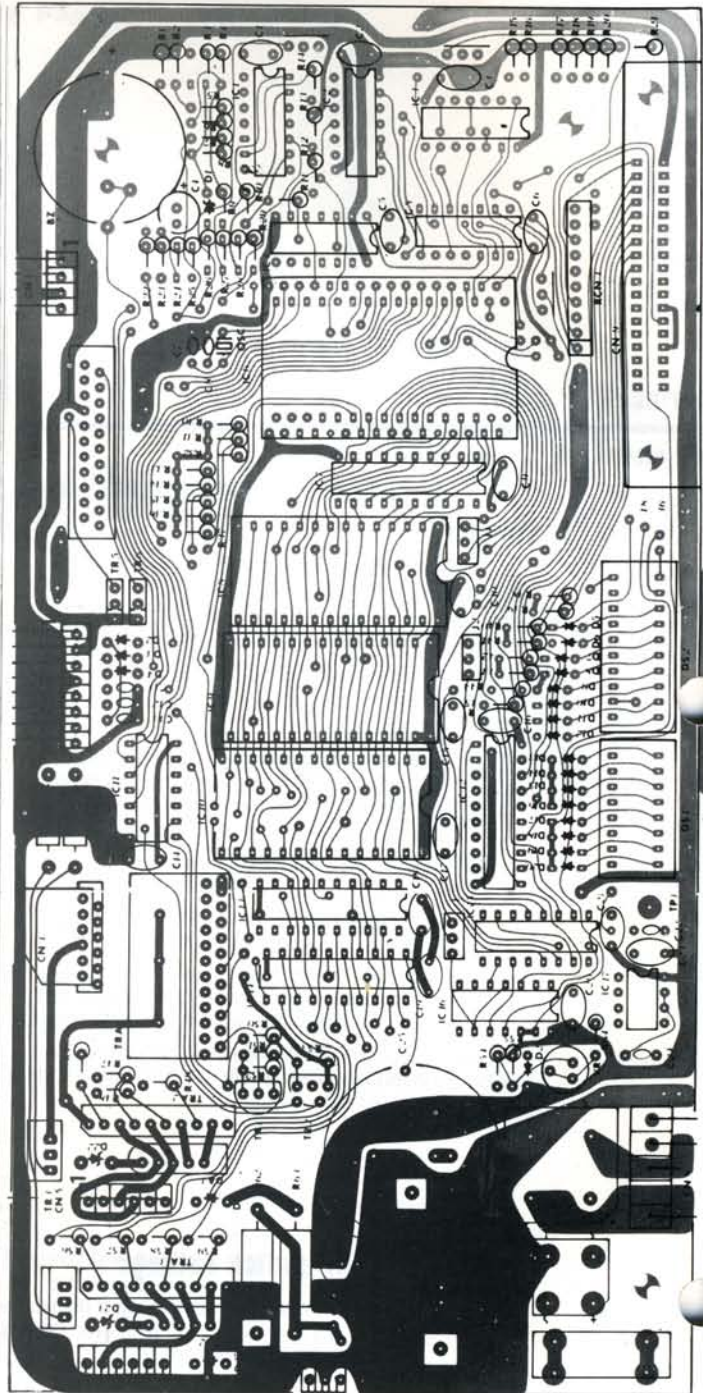
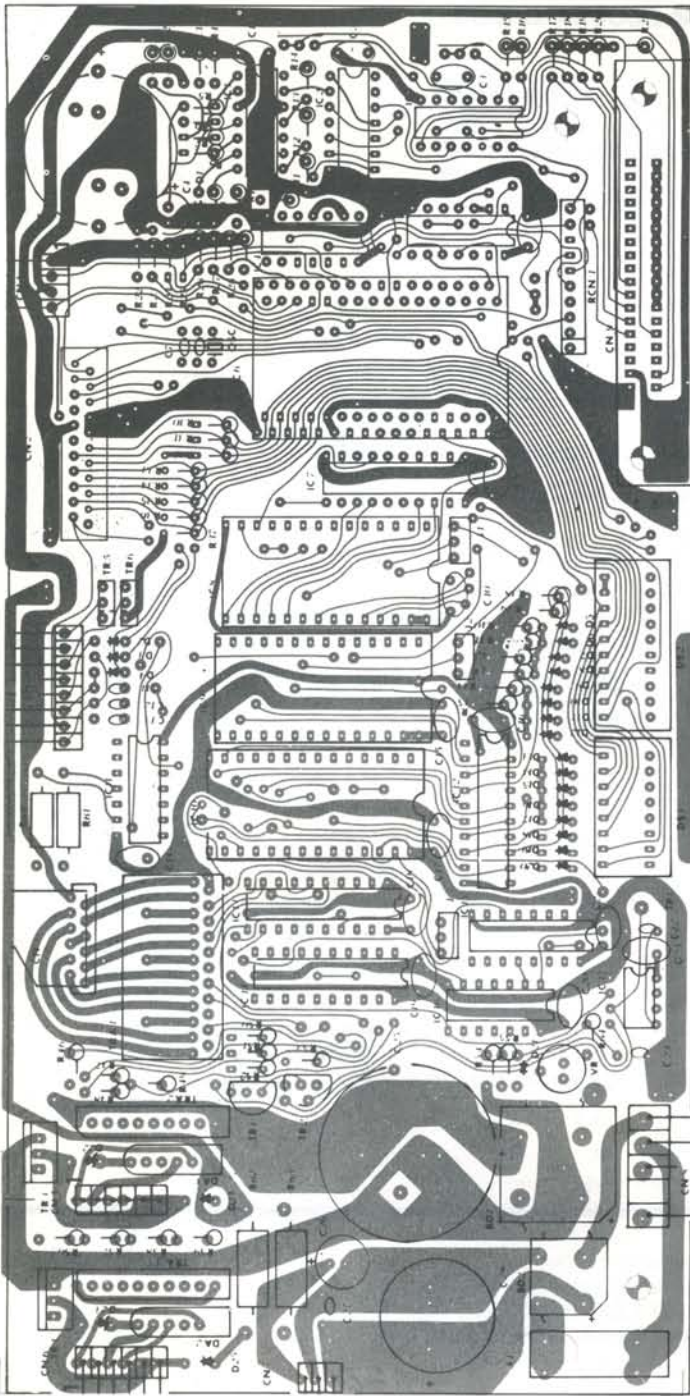

CABINET PARTS LIST

Sym	Description	DMP2000	DMP3000
1	Top Cabinet	190701	190851
2	Bottom Cabinet	190702	190852
3	Dust Cover	190703	190850
4	Rotary Knob	190704	190853
5	Shield Plate	190705	190705
6	Heat Sink		
7	Paper Guide	190706	190706
8	Metal Leg	190707	190707
9	Earth Tag		
10	Name Plate	190708	190856
11	Function Inlay	190709	190855
12	Bottom Inlay	190710	190854
13	Rubber Foot Dia 10x1.6mm	190711	190711
14	Rubber Ring		
15	Printer Mechanism	190712	190712
16	Mains Transformer	190713	190713
17	AC Power Cord BS Lead 3 Core 6'		
18	Power Switch 2Pit SDE3GE	190714	190714
19	PCB Main		
20	PCB AC		
21	PCB LED		
	Printer Ribbon	SOFT06049	SOFT50015
	Printer Cable - PL2		

CABINET DRAWING

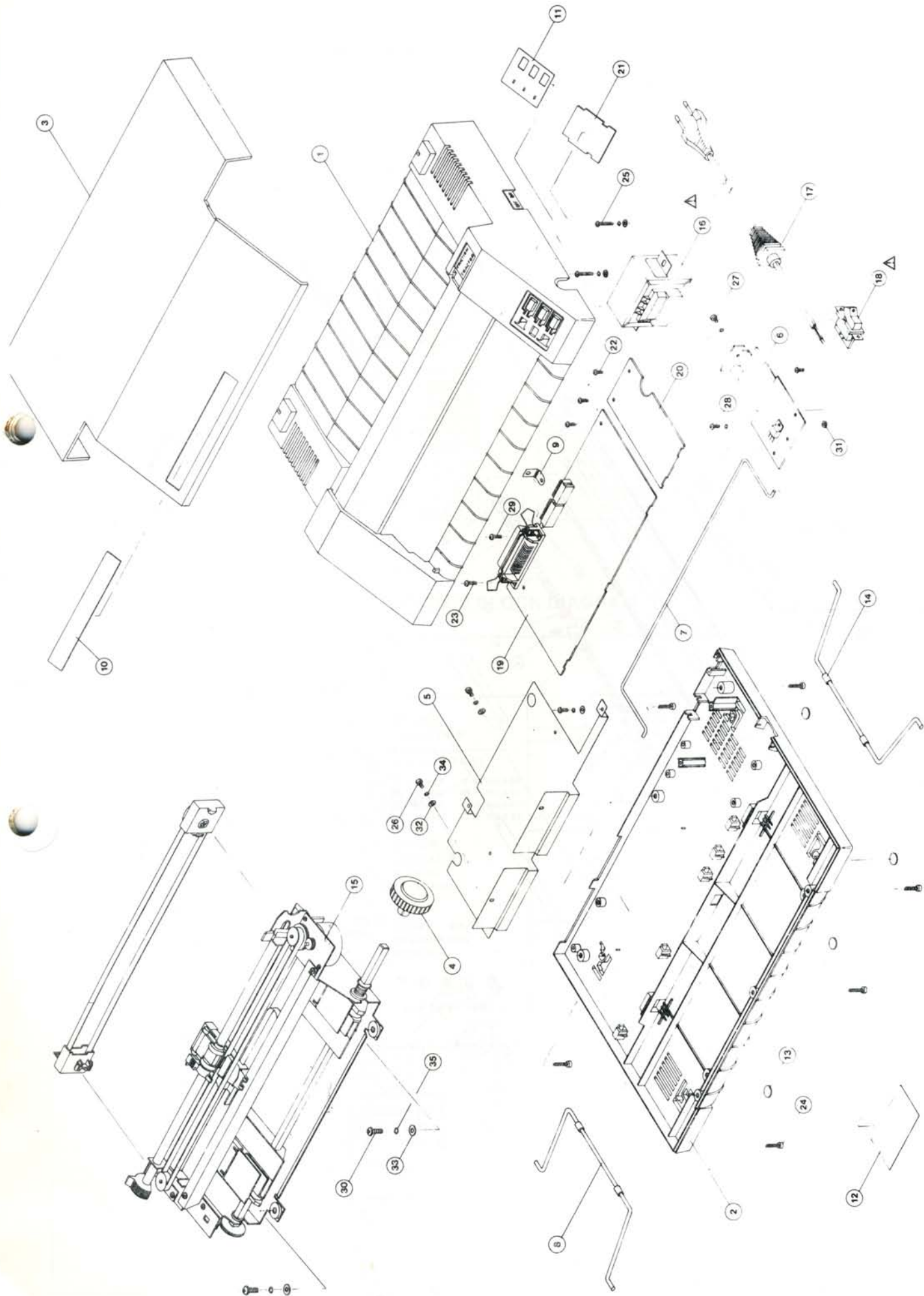

PRINTER MECHANISM

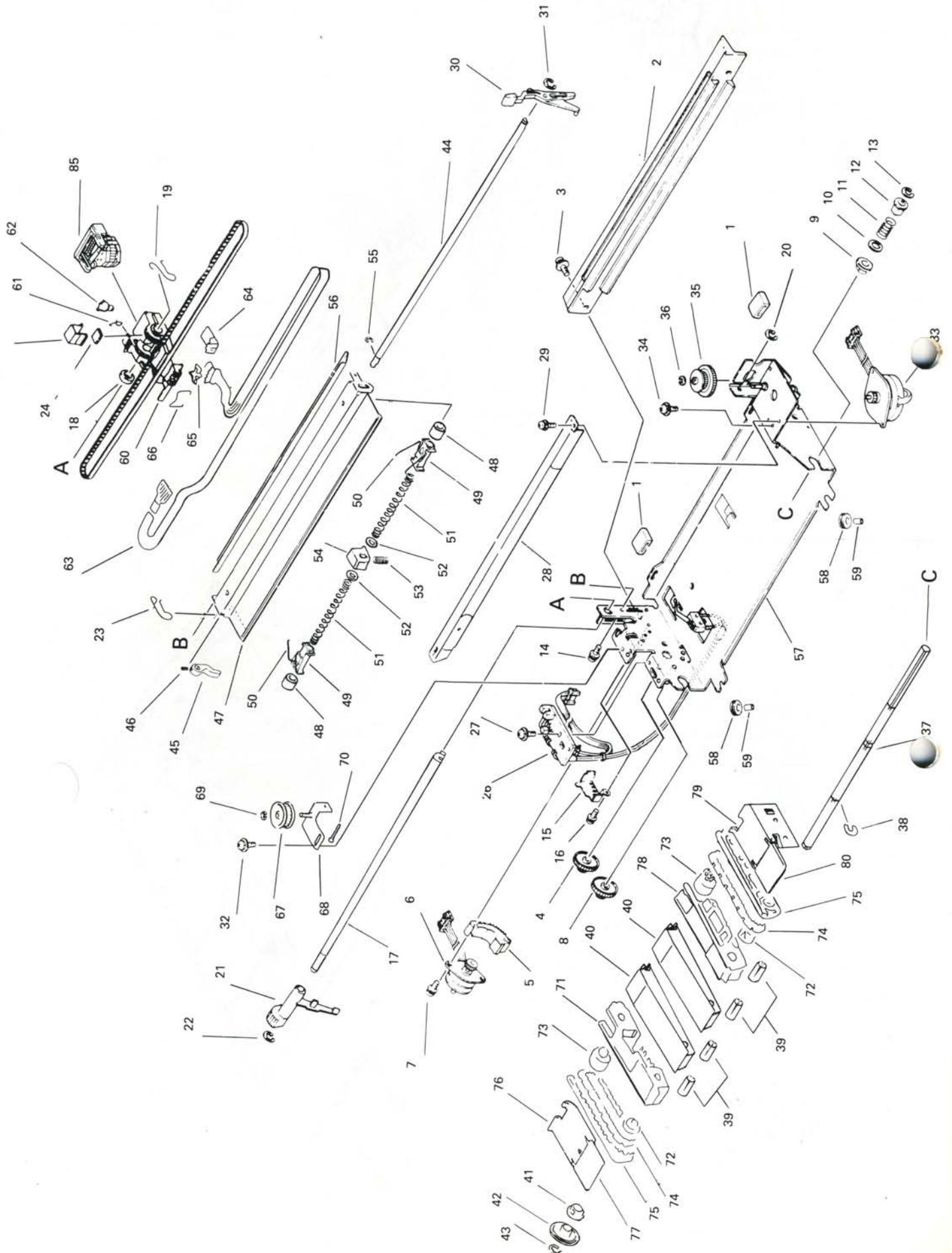

PRINTER MECHANISM PARTS LIST

Sym	Description	Part No.			
1	Damper R	190748	47	Sub Frame	190782
2	Set Platen	190749	48	Set Roller	190783
4,8	LF gear	190750	49	SP Bracket	190784
5	LF Heat Sink	190751	50	Roller Spring	190785
6	Set LF Motor	190752	51	Guide Spring	190786
9	Bush	190753	52	Washer	190787
10	Poly Slider	190754	53	Guide Spring-B	190788
11	LF Spring	190755	54	Centre Guide	190789
12	LF Collar	190756	56	Paper Press	190790
13	E Ring E-6	190757	57	Set Base	190791
15	Clip Plate	190758	58	Damper F	190792
17	Set CR Shaft	190759	59	Damper Collar	190793
18	Felt Ring	190760	60	Set Carriage	190794
19	CR Spring R	190761	61	Stopper Spring	190795
20	E Ring E-4	190762	62	Ribbon Stopper	190796
21	Gap Lever	190763	63	Set FPC	190797
23	CR Spring L	190764	64	Cable Clamp	190798
24	Upper Felt	190765	65	Pressure BD	190799
25	Upper Spring	190766	66	Pressure Spring	190800
26	Sensor Assy.	190767	67	ADJ Pulley	190801
28	Set Guide Frame	190768	68	Set ADJ. Plate	190802
30	Release Lever	190769	71	Tractor L	190803
31	E Ring E-3	190770	72	Main Sprocket	190804
33	Set CR Motor	190771	73	Set Feed Roller	190805
35	Set CR Gear	190772	74	Pin Belt	190806
36	E Ring E-2	190773	75	Tractor Plate	190807
37	LF Shaft	190774	76	Tractor Cover L	190808
38	C Ring	190775	77	Cover Plate L	190809
39	Tractor Stopper	190776	78	Tractor R	190810
40	Paper Guide	190777	79	Tractor Cover R	190811
42	LF Shaft Gear	190778	80	Cover Plate R	190812
44	Roller Shaft	190779	85	Print Head With Ribbon Mask	190813
45	S Release Lever	190780			
46	Screw M3x6	190781	86	Printer Ribbon	SOFT06049

DMP2000/3000 BLOCK DIAGRAM

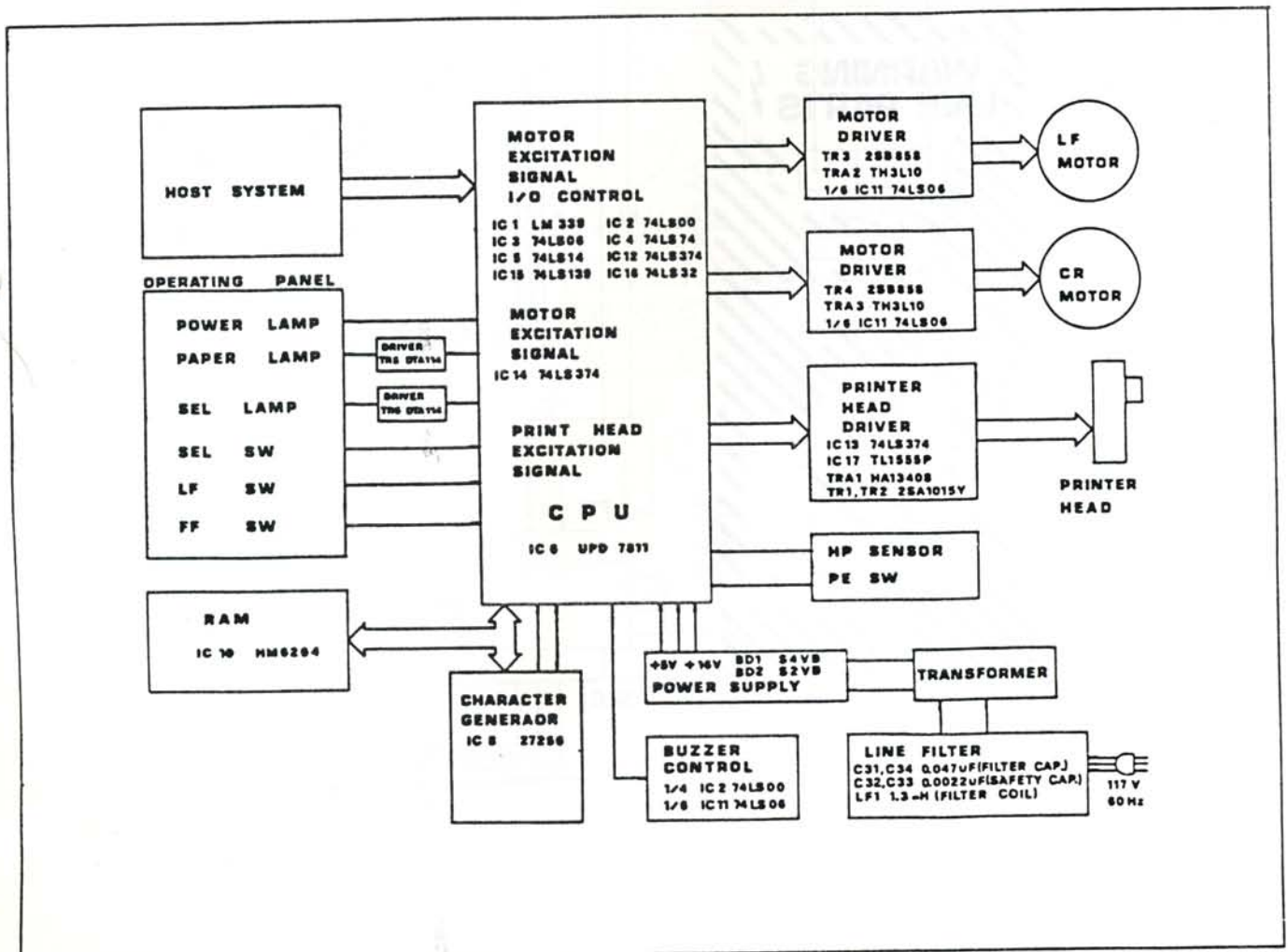

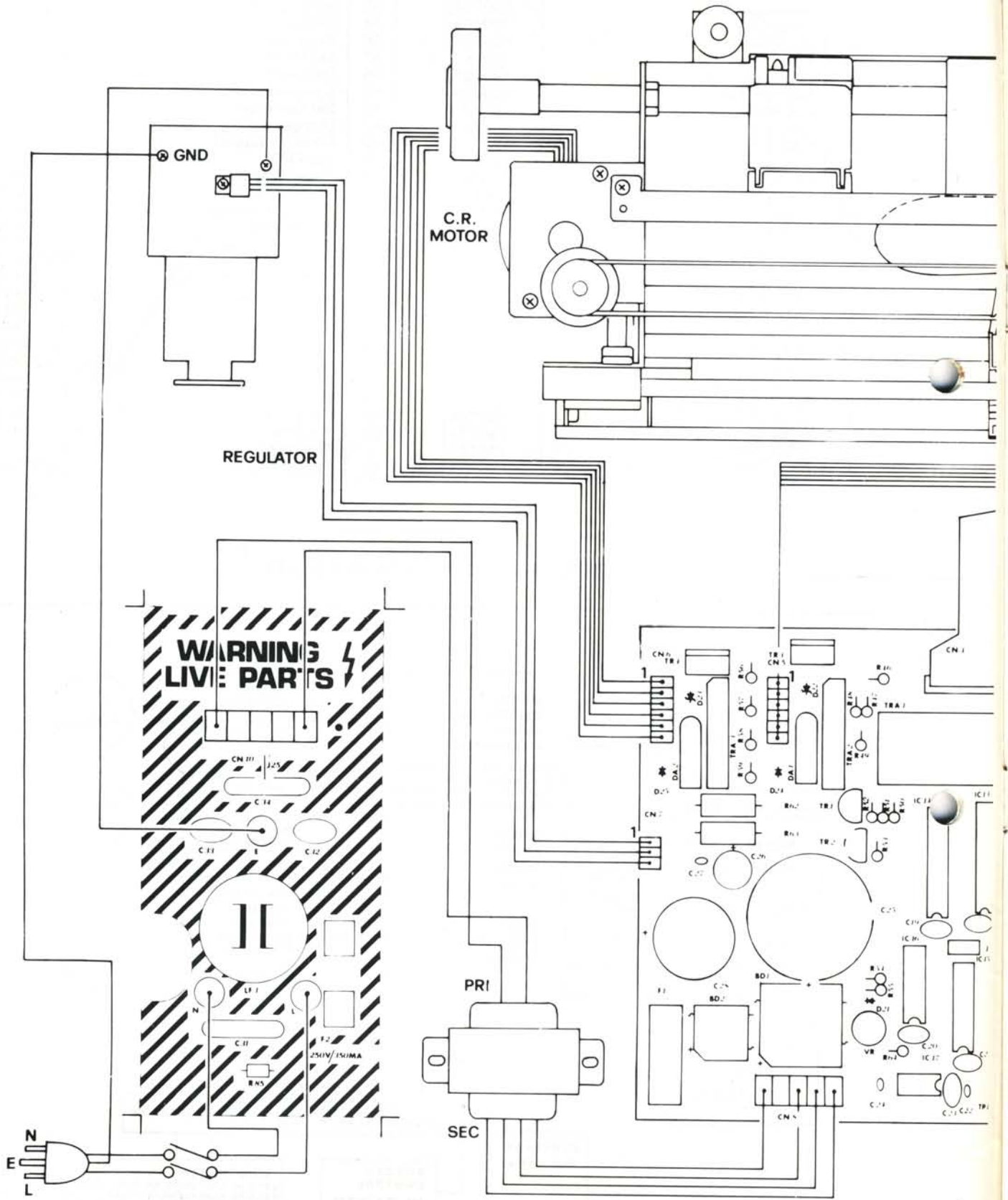

WIRING DIAGRAM

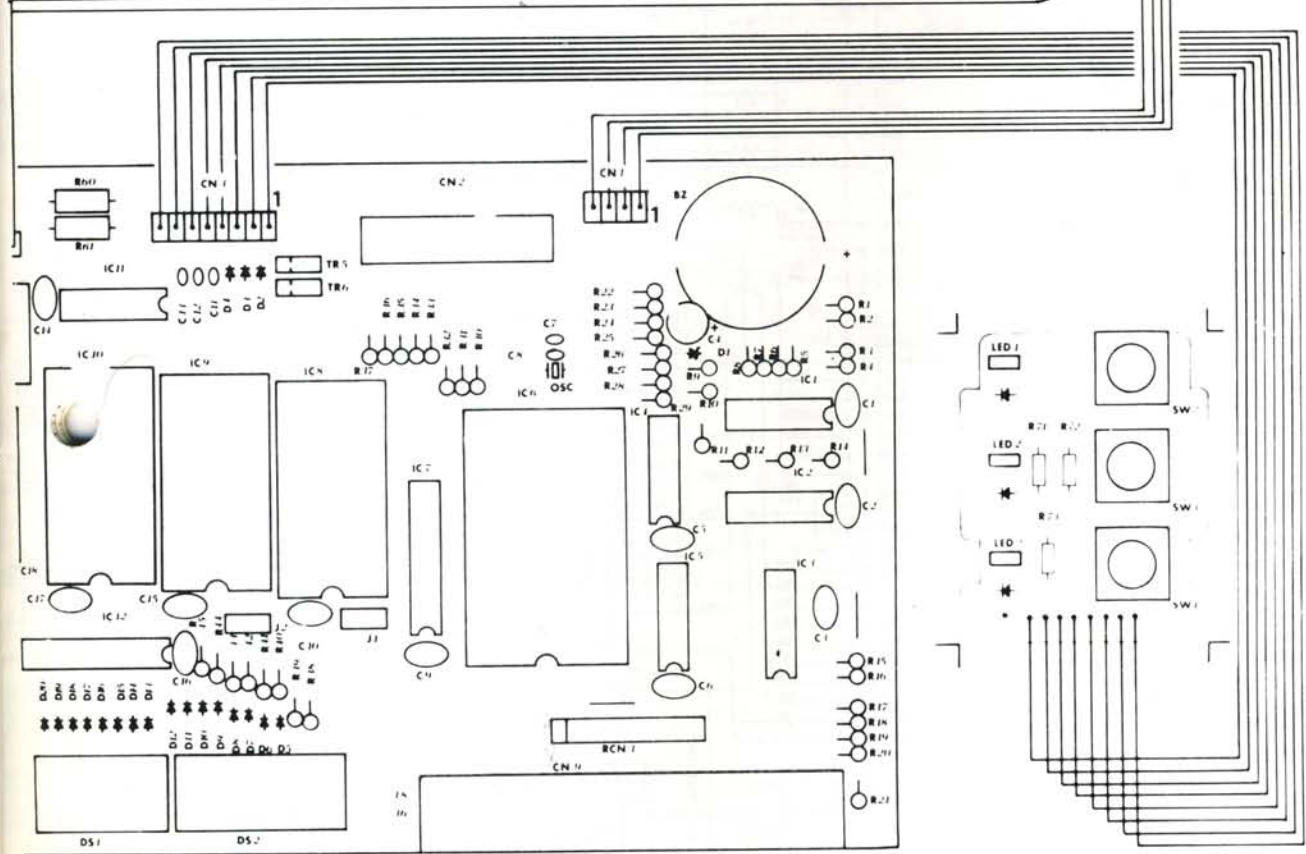
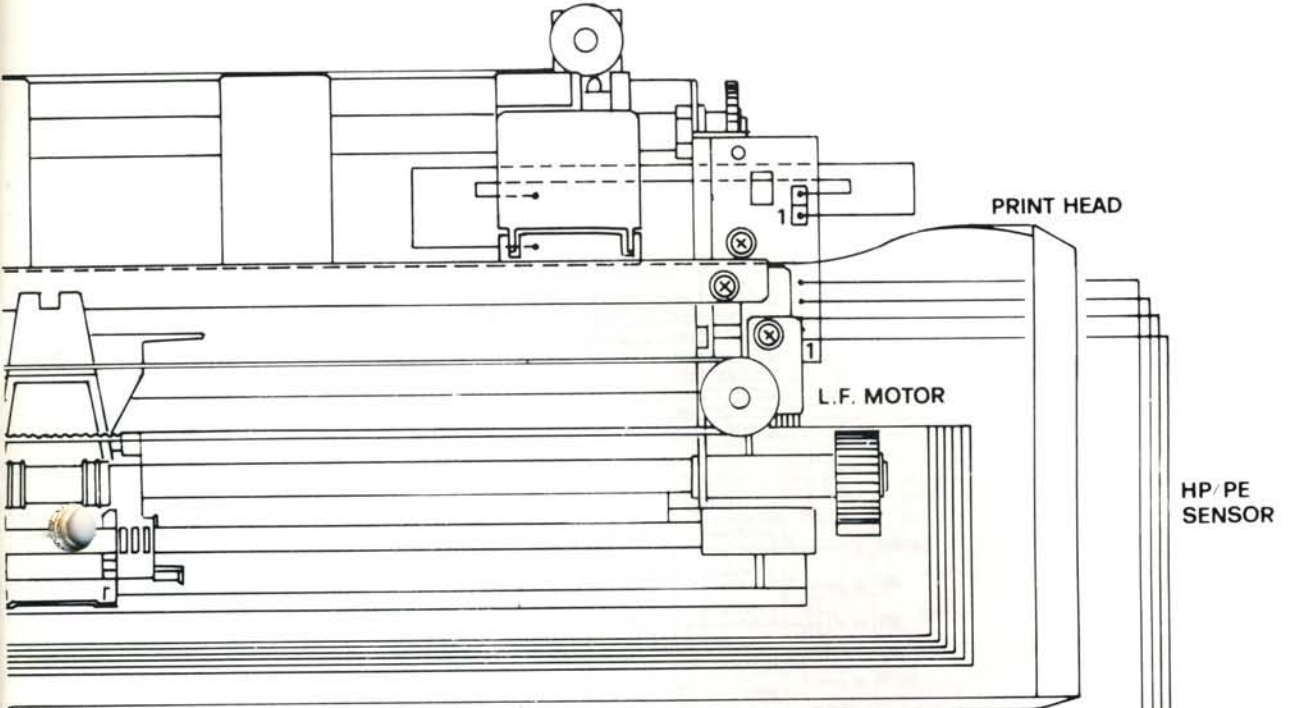

FUNCTION KEY

	DMP 2000	DMP 3000
IC 8	USING 1PC 27128	USING 1PC 27256
IC 9	27128	27256
IC 9	NIL	NIL
IC 10	6116 OR 8128	6264
J 1	2 - 3	1 - 2
J 2	1 - 2	1 - 2
J 3	2 - 3	1 - 2
J 5	1 - 2	2 - 3
IC 8	USING 2PCS 2764	USING 2764 & 27128
IC 8	2764	2764
IC 9	2764	27128
IC 10	6116 OR 8128	6264
J 1	1 - 2	1 - 2
J 2	2 - 3	2 - 3
J 3	2 - 3	1 - 2
J 5	1 - 2	1 - 2
J 4	AMSTRAD COMPUTER	NON AMSTRAD COMPUTER
J 4	2 - 3	1 - 2

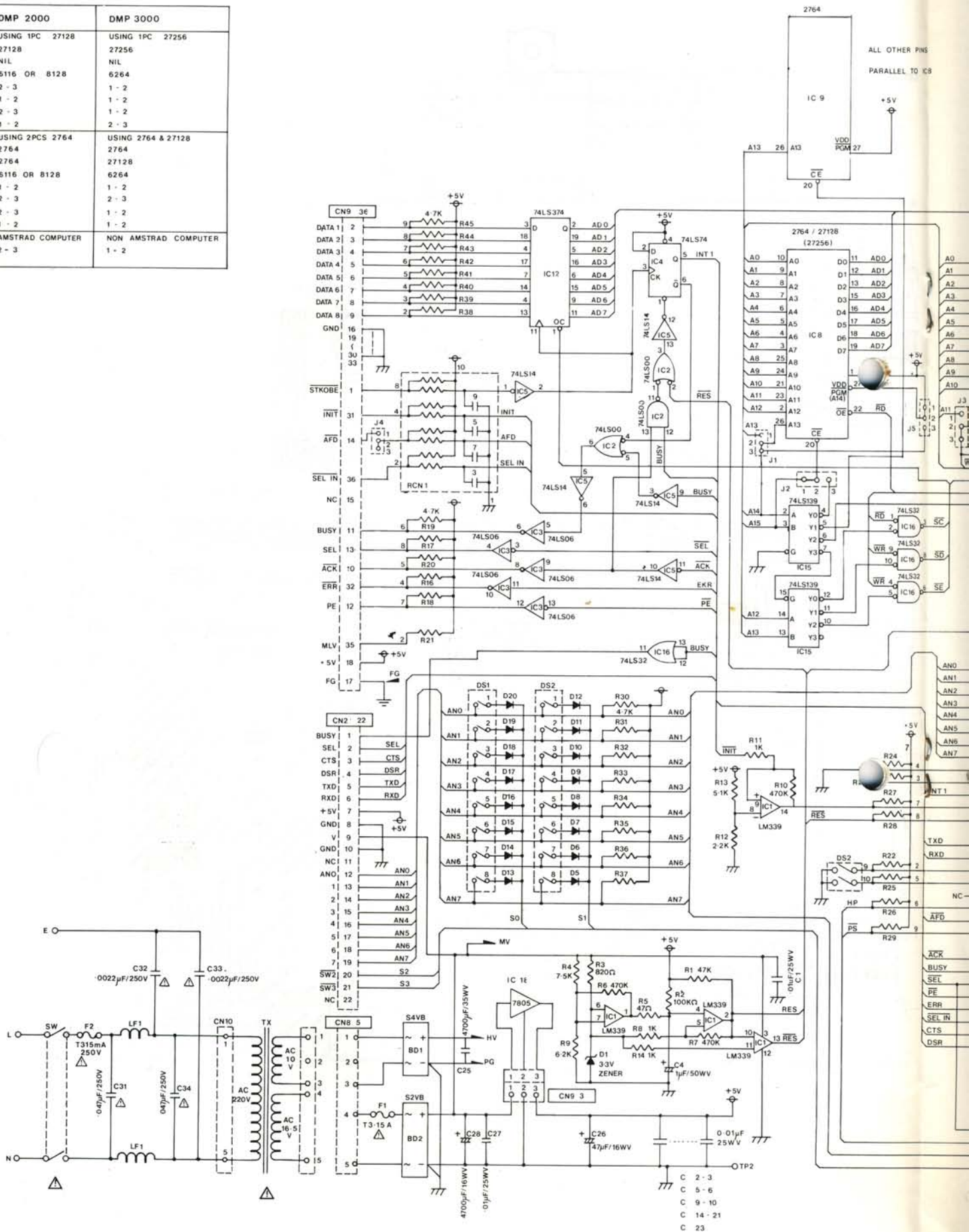

DO CIRCUIT DIAGRAM

PINS
TO IC3

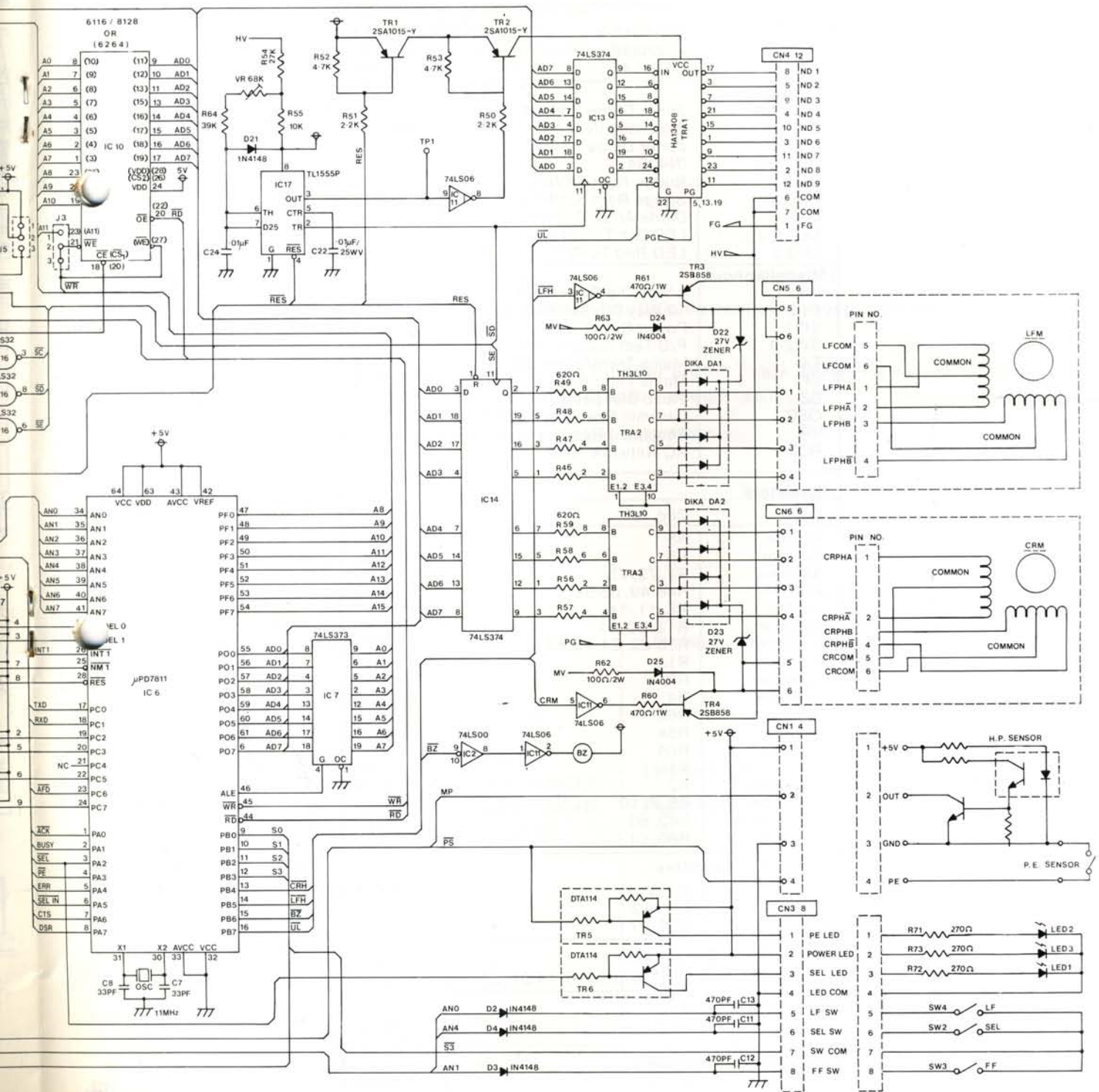

ELECTRICAL PARTS LIST

Circ. Ref.	Description	Part No.
IC's		
IC1	LM339/HA17339	190724
IC2	HD74LS00P	190728
IC3, 11	MB74LS06	190729
IC4	HD74LS74AP	40014
IC5	HD74LS14P	190730
IC6	uPD7811G-071	190733
IC7	HD74LS373P	170108
IC8	HN4827128G-25 50nS	190722
IC10	MB8128-15	190723
IC12-14	HD74LS374P	190727
IC15, 16	HD74LS139P	190726
IC17	HA17555	190725
TRA1	HA13408	190814
TRA2, 3	TH3L10	190734
IC18	L7805CY	190731
Transistors		
TR1, 2	2SA1015-Y	170453
TR3, 4	2SB858B	190721
TR5, 6	DTA114E	151096
Diodes		
D1	Zener Diode 3.3V DC	190719
D2-22	Sig Diode IN4148	190715
D23	Zener Diode 27VDC	190720
D24, 25	IN4004	190716
BD1	Bridge Rect S4VB10	190718
BD2	Bridge Rect S2VB10	190717
DA1, 2	Diode Array D1CA	190815
LED1, 2	LED Grn TLG211	190744
LED 2	LED Red TLR211	190743
Miscellaneous		
DS1	8 Way Dip Switch N/O	190737
DS2	10 Way Dip Switch N/O	190738
SW1	Power Switch 2Pit	▲190714
SW2-4	P/B Tact Switch 1 Pit	190739
TX	Mains Transformer BS	▲190713
LF1	Mains Filter Coil	▲190740
BZ	Piezo Bleeper	190736
OSC	Ceramic Resonator 11MHz	190742
VR	Semifixed Resistor 68 ohm	190745
RCN1	RC Network T002	190732
Resistors		
Desc.	Circ. ref.	Part No.
47ohm	R5	10020
82 ohm	R3	10031
330ohm	R7, 72, 73	10044
620ohm	R46-49, 56-59	190816
1kohm	R8, 11, 14	10061
2.2kohm	R12, 50, 51	10069
4.7kohm	R15-22, 24-45, 52, 53	10077
5.1kohm	R13	190817
6.2kohm	R9	190818
7.5kohm	R4	190819
10kohm	R55	10085
27kohm	R54	10095
39kohm	R64	10099
47kohm	R1	10101
100kohm	R2	10109
470kohm	R6, 7, 10	10131
100ohm/2W	R62, 63	190820
470ohm/1W	R60, 61	190821
Ceramic Capacitors		
33pF	C7, 8	150514
470pF	C11-13	190822
0.01uF	C22, 27	24011
Mono Glass Capacitors		
0.1uF/50V DC	C1-3, 5, 6, 9, 10, 14-21, 23	190823
Mylar Capacitors		
0.01uF	C24	2f006
Electrolytic Capacitors		
1uF/50V	C1, 4	20062
47uF/16V	C26	20049
4700pF/16V	C28	150479
Polystyrene Capacitors		
0.0022uF/250V	C32, 33	▲190824
0.047uF/250V	C31, 34	▲190825

DMP4000 SECTION

CONTENTS

	Page
Technical Specification	13
Safety Note	13
Exploded View & Parts List	14
Cabinet Drawing & Parts List	15
Component Layouts	16
Layouts/Masks	17
Electrical Parts List	18
Wiring Diagram	19
Circuit Diagram	20

SAFETY TEST

PLEASE NOTE: When any work is completed on this unit, correct safety tests must be carried out to ensure continued electrical safety.

PLEASE NOTE: All parts shown with the part number prefix are Safety Items and must be replaced with similar items having an identical safety specification.

All of these items may be purchased direct from AMSTRAD PLC.

<p>Print system: Wire dot-matrix</p> <p>Print speed: 200 CPS (standard) 50 CPS (NLQ)</p> <p>Printing characteristics (vertical x horizontal): 9 x 9 (ASCII characters - table 1) 18 x 9 (ASCII characters - table 2) 12 x 11 (special characters - tables 3.1 and 3.2) 24 x 11 (special characters - tables 4.1 and 4.2) 8 x chosen amount (bit-image graphics)</p> <p>Characters: ASCII - 96 Italics - 96 NLQ - 96 NLQ italics - 96 International character sets - 9 Special characters - 132</p> <p>Print sizes: Standard (Pica) - 10 CPI / 136 CPL Mini (Elite) - 12 CPI / 163 CPL Condensed - 17 CPI / 233 CPL</p> <p>Number of columns: 136 (standard) 233 (condensed)</p>	<p>Line feed rates: 1/6 inch 1/8 inch 7/72 inch 1/72 inch programmable 1/216 inch programmable</p> <p>Line feed speed: 100 mS (1/6 inch)</p> <p>Paper type: Tractor feed (fan fold) - 3 to 16 1/2 inches (75 to 420 mm) Friction feed (cut sheet or roll) - 2 to 15 1/2 inches (50 to 395 mm)</p> <p>Interface: Parallel (Centronics compatible)</p> <p>Mains supply: 220-240 Volts AC 50 Hz</p> <p>Dimensions: 24 (width) x 14 (depth) x 5 (height) inches (600 x 350 x 120 mm)</p> <p>Weight: 9.5 kg</p>
---	---

MECHANISM PARTS LIST

PRINTER MECHANISM EXPLODED VIEW & PARTS LIST

Sy	Description	Part No.
1	Print Head	190972
2	Tractor Bearing	190974
3	Tractor Gear	190975
4	Idler Gear A	190977
5	Idler Gear B	190979
6	Platen Gear	190980
7	Carriage Shaft	190985
8	Set Gap Lever A	190986
9	Pressure Roller Spring (R)	190989
10	HP Sensor Assy	190991
11	Ribbon Wire	191050
12	Wire Spring	191051
13	Guide Shaft	190992
14	CR Motor Assy.	190993
15	CR Wire	191052
16	Paper Guide M	190994
17	Tractor L	190995
18	Tractor R	190996
19	Set CR Frame A	190999
20	Cassette Catch	191000
21	FPC Guide	191001
22	Set Clutch Plate	191002
23	Clutch Spring	191003
24	RFD Gear	191004
25	RD Gear	191005
26	Set CR Frame B	191006
27	CR Guide	191007
28	Ribbon Drive	191008
29	Set Free Arm	191013
30	Bearing	191014
31	Set Release Lever	191015
32	Release Lever Spring	191016
33	Set Link Lever	191017
34	Platen	191018
35	Bearing A	191019
36	Paper Press	191020
37	Stopper Roller	191021
38	Spring Stopper Roller	191022
39	Stopper Shaft	191023
40	Set P Lever (R)	191024
41	Set P Lever (L)	191025
42	Set Roller Bracket (R)	191053
43	Set Pulley D16	191054
44	Friction Spring	191029
45	LF Motor Assy	191032
46	Paper Chute	191033
47	Release Shaft	191034
48	Roller Lever	191035
49	Roller	191036
50	Friction Arm	191037
51	Torque Spring	191038
52	Bearing	191039
53	Set Roller Bracket (L)	191040
54	PE Lever	191043
55	PE Spring	191044
56	PE Sensor Assy	191045

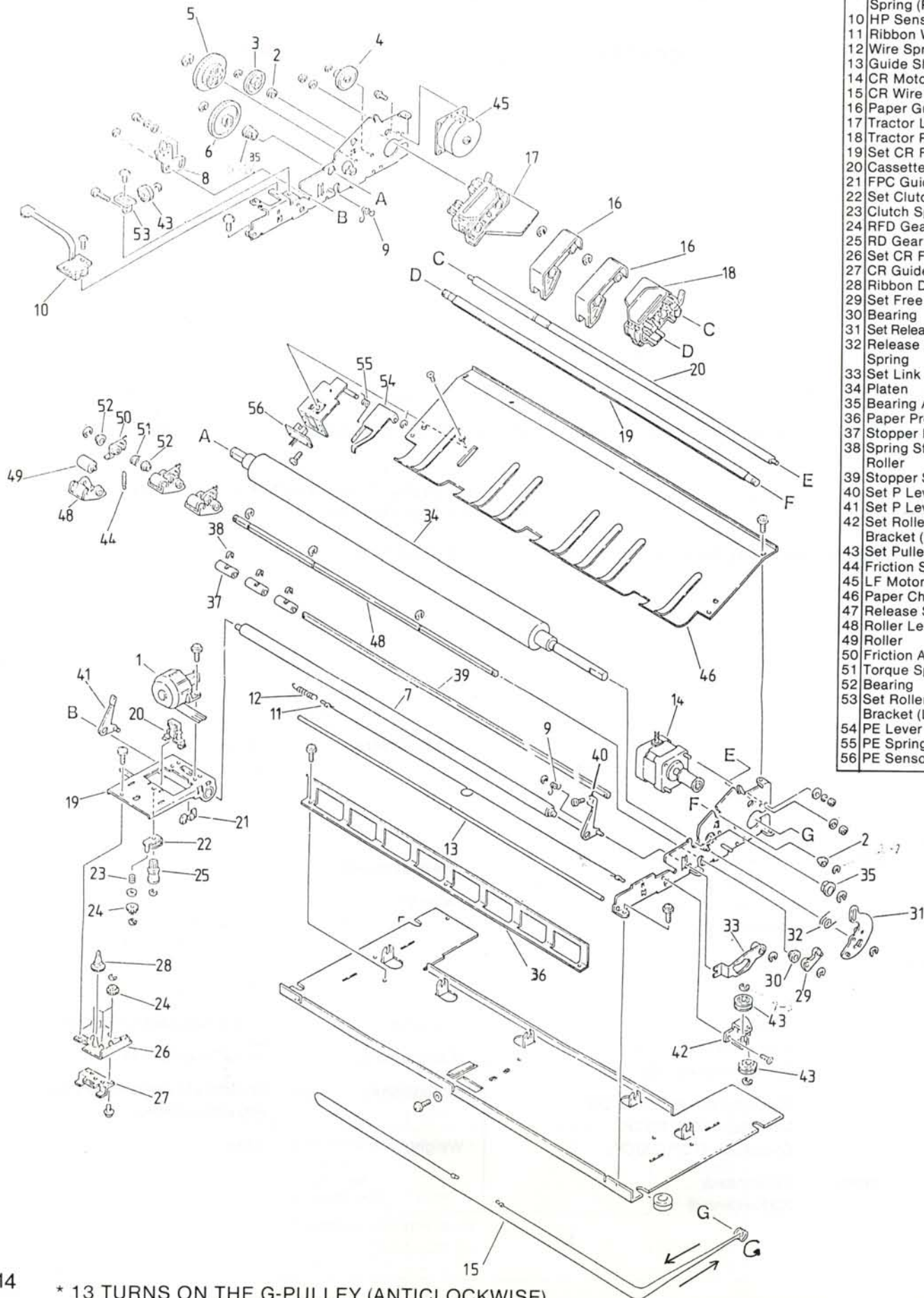

72
74
75
77
79
80
85
86
89

91
90
91
50
51
92
93
52
94
95
96
99
00
01
02
03
04
05
06
07
08
13
14
15
16

17
18
19
20
21
22

23
24
25
53

54
29
32
33
34
35
36
37
38
39
40

43
44
45

CABINET PARTS LIST

Sym	Description	Part No.
1	Top Cabinet	190936
2	Bottom Cabinet	190937
3	Upper Dust Cover	190934
4	Lower Dust Cover	190935
5	Rotary Knob	190941
6	Roller Release Knob	190942
7	Push Button	190940
8	Printer Mechanism	190929
17	Name Plate	190946
18	Function Inlay	190944
19	Bottom Inlay	190943
22	Rubber Foot	190945
23	Mains Transformer	△190931
25	Power On/Off Switch	△190920
30	Printer Ribbon (not a spare part)	SOFT 50015

CABINET DRAWING

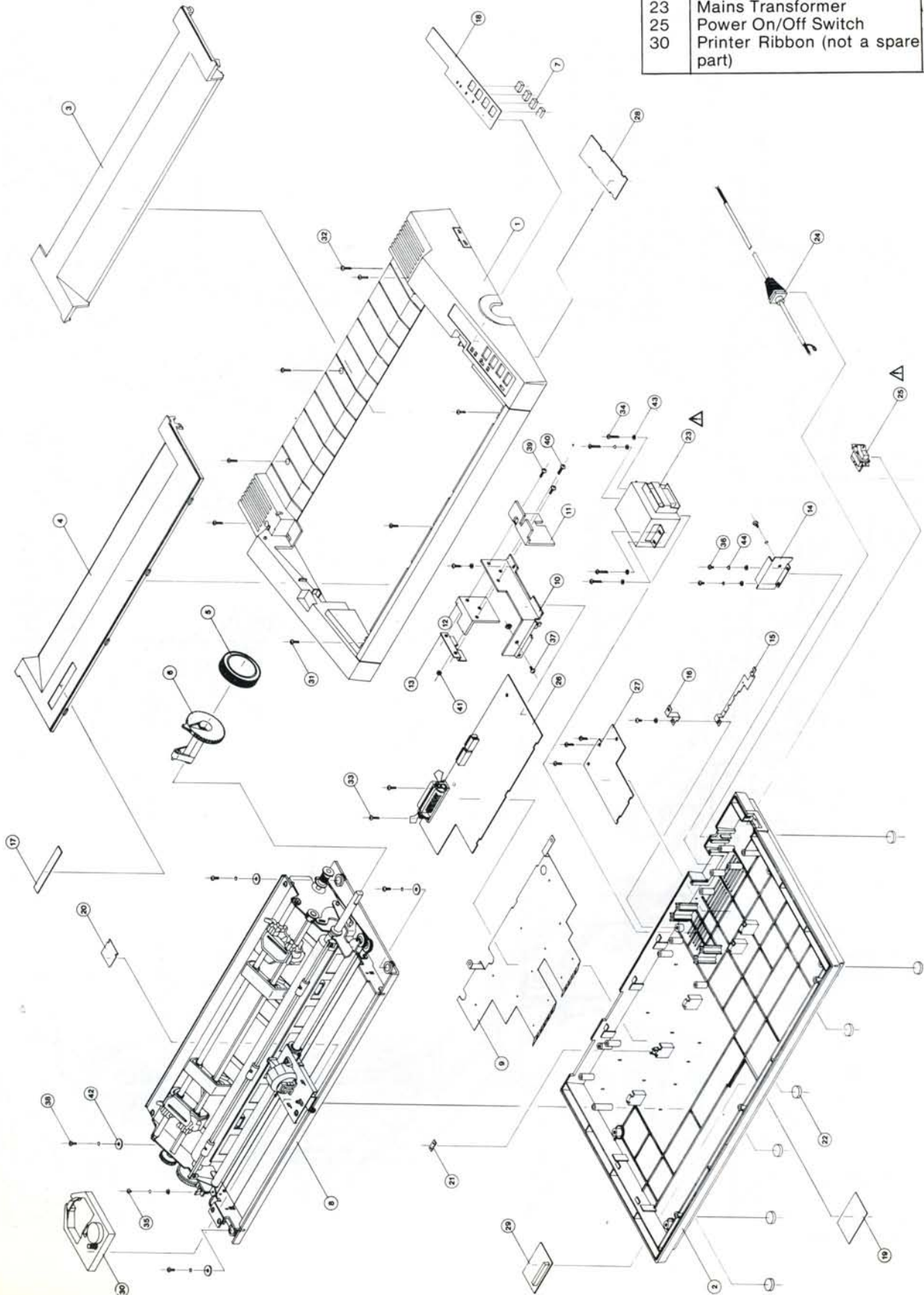

COMPONENT LAYOUTS

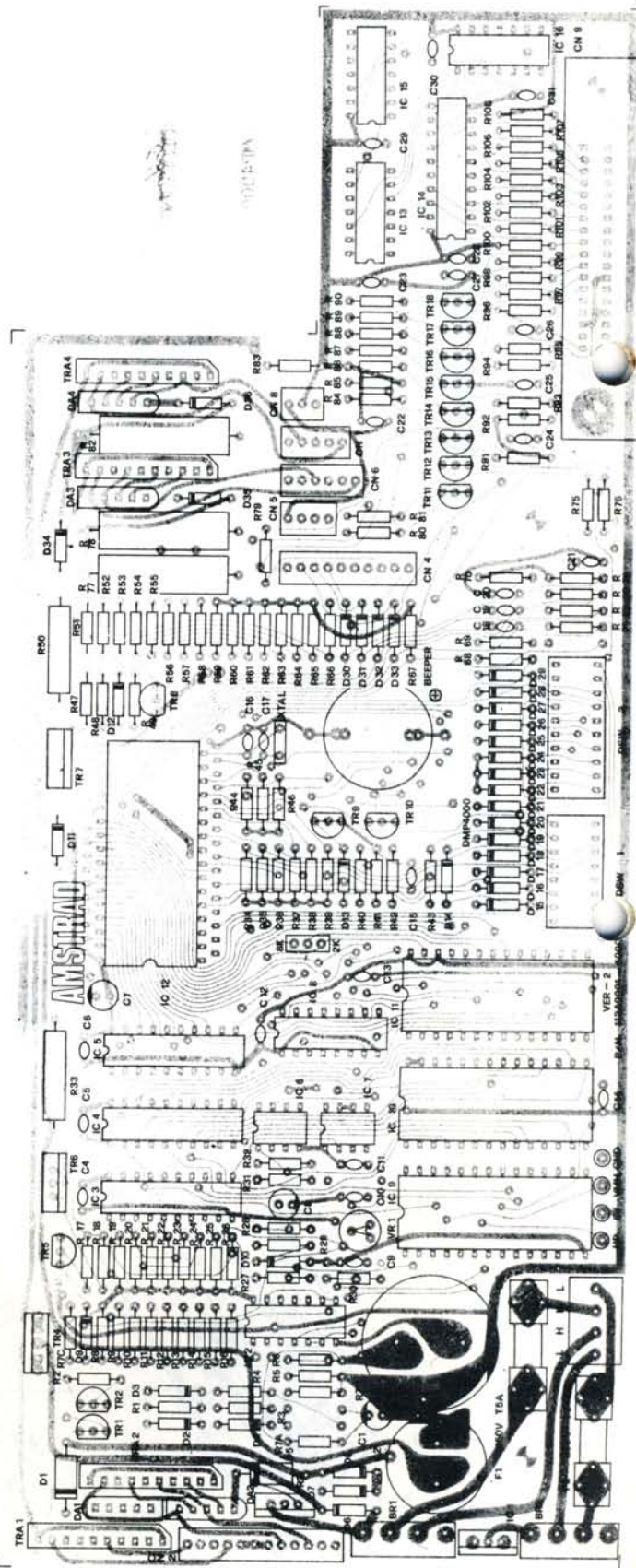
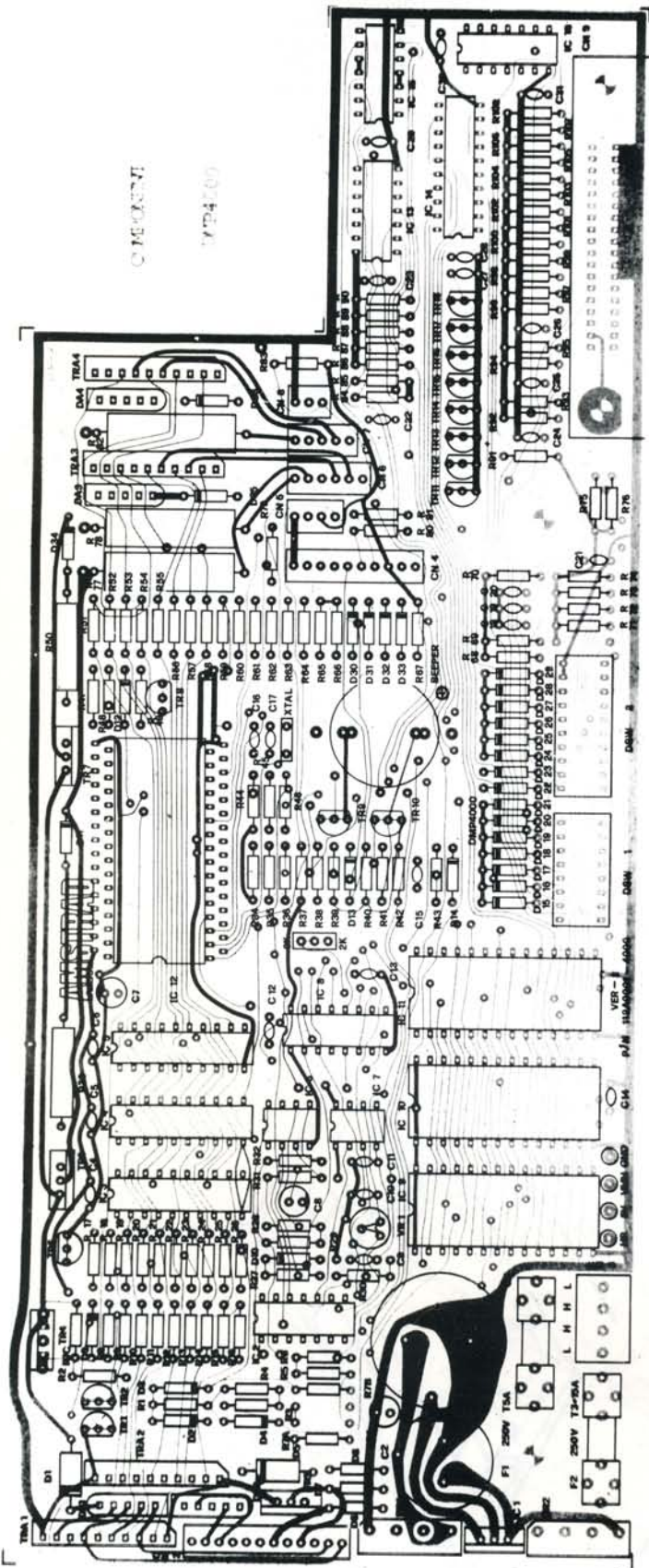

PCB LAYOUTS

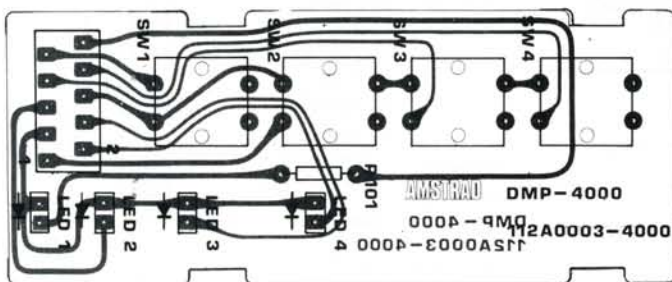
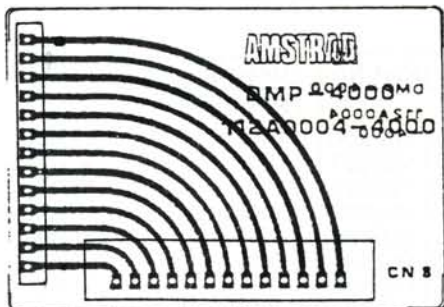

DMP4000
ELECTRICAL PARTS LIST

Ref. No.	Description	Part No.
IC's		
IC6	IC LM393	190900
IC7	IC NE555	190901
IC8	IC 74LS139	190722
IC3	IC 74LS273	190903
IC4	IC 74LS373	170108
IC14	IC 74LS374	190727
IC5	IC 74LS377	190904
IC15	IC 74LS00	190728
IC2	IC 74LS02	190905
IC13	IC 74LS14	190730
IC16	IC 74LS74	40014
IC1	IC Regulator 7805	190731
IC10	IC UPD7811	190733
IC9	IC EPROM 256K 250nS	190857
IC11	IC S.RAM 6264-15	190858
	IC 28 Way Socket	190506
Transistors		
TR1, 2, 5, 8, 9, 11-18	TR 2SC3656	190908
TR4	TR 2SB882	190909
TR6, 7	TR 2SB886	190910
TR3	TR 2SD1196	190911
TRA1-4	TR Array TH3L10	190734
PH1, 2	TR SP5216	191046
TR20	TR DTC114N	191047
TR19	TR 2SC1815	170447
Diodes		
D2-4, 9, 12-33	D IN4148	190715
D6, 7, 11, 34	D IN4004	190716
BR1, 2	D Bridge Rect. KBL02	190912
D10	D Zener 3.3V 0.5W	190913
D35, 36	D Zener RD47F 47V	190915
D1, 5, 8	D Zener IN6275	190916
DA1-4	D Array DICA20	190917
LED1, 2	LED Red	190926
LED3, 4	LED Green	190927
Switches		
SW	Mains Switch	⚠190920
DSW1	Dip Switch 8 Way	190737
DSW2	Dip Switch 10 Way	190738
SW1-4	Tact Switch	190921

Description	Ref. No.	Part No.
Resistors		
18ohm	R43	10012
180ohm	R112, 113, 116	
220ohm	R41	10040
330ohm	R79-81, 201	10044
470ohm	R92, 94	10048
680ohm	R1, 9-16, 51-58	10052
1kohm	R3, 18, 42, 45, 47, 67-74, 78, 87-90, 93, 96-108	10061
2k2ohm	R4, 19-27, 59-66	10069
4k7ohm	R8, 17, 34-39, 40, 44, 46, 48, 49, 75, 76, 83-86, 91, 95, 110, 115	10077
5k1ohm	R5, 28	10078
6k8ohm	R29, 114	10081
10kohm	R31, 70	10085
18kohm	R6	10091
22kohm	R7A, 111	10093
51kohm	R30	10102
470kohm	R32	10125
7.5ohm/3W	R77, 78	10055
22ohm/2W	R50	191056
36ohm/2W	R33	191057
Ceramic Capacitors		
22pF	C16, 17	150511
100pF	C11	24016
470pF	C24, 25, 27, 31	24004
0.001uF	C9, 18-21	24027
0.01uF	C10	24011
0.22uF/250V	C102, 103	⚠191058
0.047uF/250V	C101, 104	⚠191059
0.1uF	C4-6, 12-14, 22, 23, 26, 28-30	24020
Electrolytic Capacitors		
1uF/50V	C8	20062
10uF/16V	C7	20024
4700uF/16V	C2	150479
6800uF/C3		191060

Circ. Ref.	Description	Part No.
Miscellaneous		
LF1	Filter Coil 1.3mH	190918
X Tal	11 MHz Ceramic Resonator	190919
VR1	Semi Fixed Resistor 68kohm	190928
	Piezo Bleeper	190736
	Printer Cable - PL2	190947
	Instruction Book	190948
	36 Way Connector	190949
	Fuse T1A 250V	⚠190959
	Fuse T5A 250V	⚠190960
	Fuse T3.15A 250V	S/88150

No. 12 40 44 48 52 61 69 77 78 81 85 91 93 02 25 55 56 57 11 16 04 27 11 58 59 20 32 24 79 60

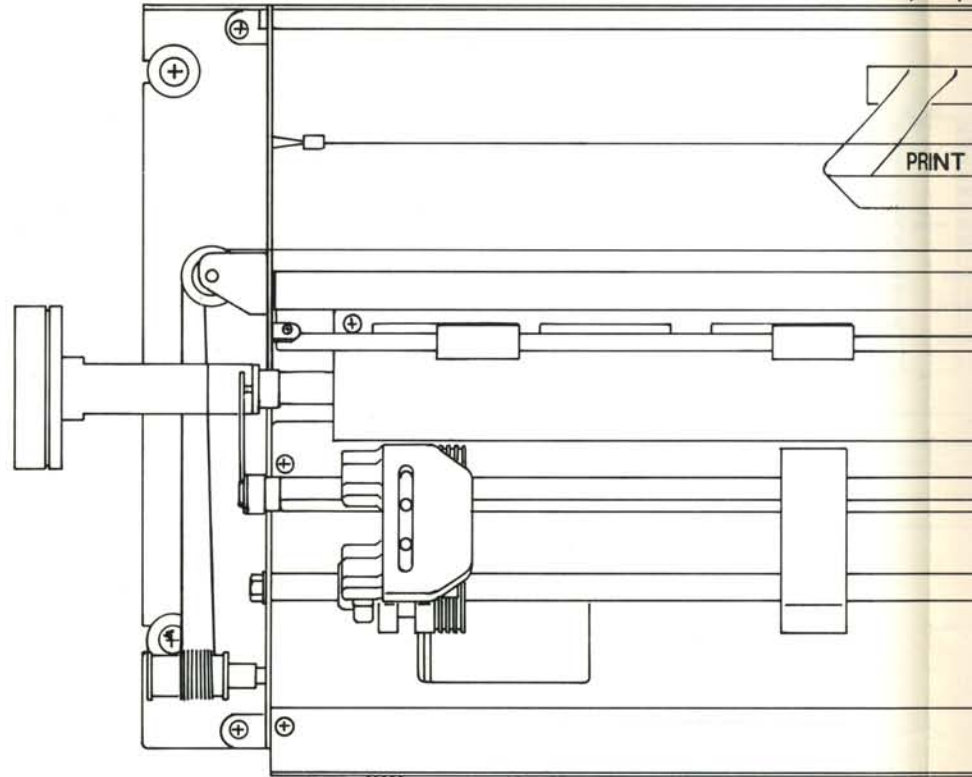
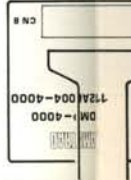

C.R. MOTOR

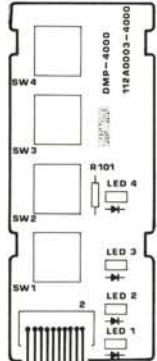

FUNCTION KEY

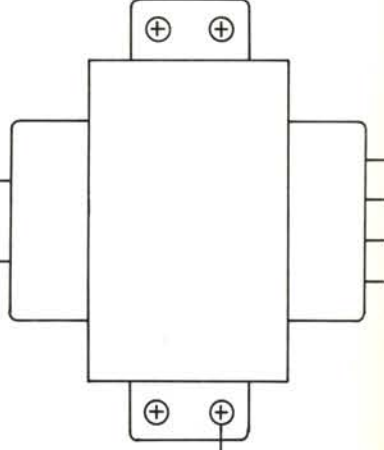
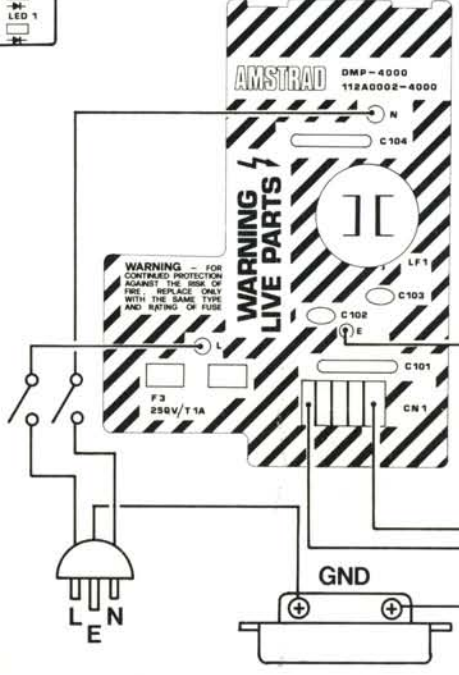

HEAT SINK



L E N

WIRING DIAGRAM

PRINT HEAD

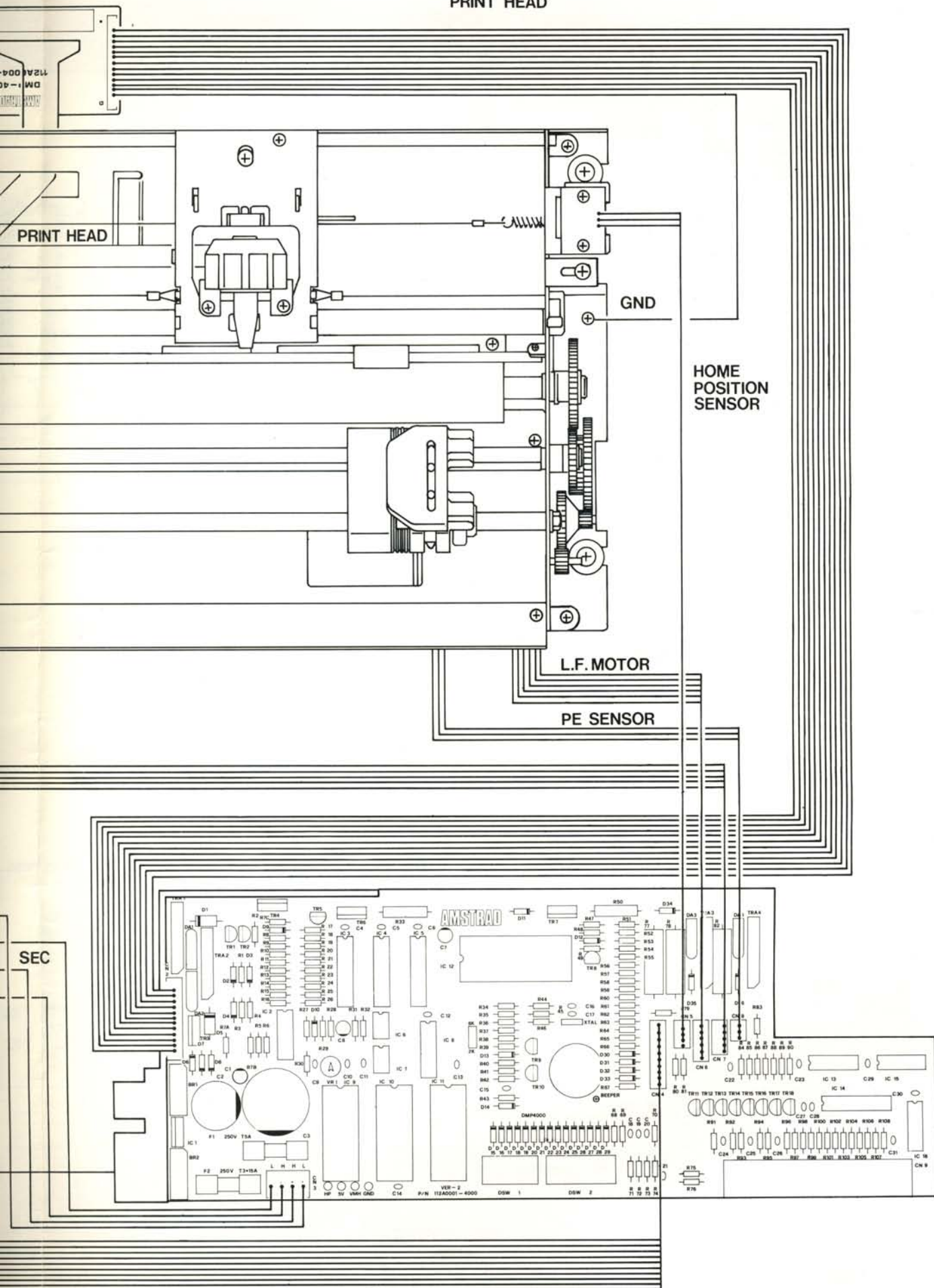

CIRCUIT DIAGRAM

